

LANs and WANs

ITS323: Introduction to Data Communications
CSS331: Fundamentals of Data Communications

Sirindhorn International Institute of Technology
Thammasat University

Prepared by Steven Gordon on 13 October 2015
ITS323Y15S1L11, Steve/Courses/2015/s1/its323/lectures/lans-and-wans.tex, r4135

Contents

General Network Issues

Network Topologies

Medium Access Control

Example Network Technologies

Categorizing Network Technologies

Transmission Medium

- ▶ Wired vs Wireless

Link Configuration

- ▶ Point-to-point vs Point-to-multipoint

User Mobility

- ▶ Fixed vs mobile

Types of Users

- ▶ Access vs core (backbone)

Coverage Area

3

Selecting the Transmission Medium

Wired

- + No interference from others → high data rates, easy to upgrade capacity
- + Small, predictable delay
- Expensive to install in hard to access locations
- Device locations are fixed

Wireless

- + No physical connection → mobility, convenience
- Interference, varying channel conditions → poor performance
- Licenses often required
- Hard to add more capacity
- Physical security is difficult

4

Selecting the Link Configuration

Point-to-point

- + Dedicated link for users → high, predictable performance
- Need many links, planning of end-points (Topology)
 - Wired links, wireless links with directional antennas

Point-to-multipoint

- + Cover multiple users with single link
- Requires sharing of medium: multiple access, Medium Access Control protocol
 - Wireless links with omnidirectional antennas, shared wired links

5

Access vs Core Network

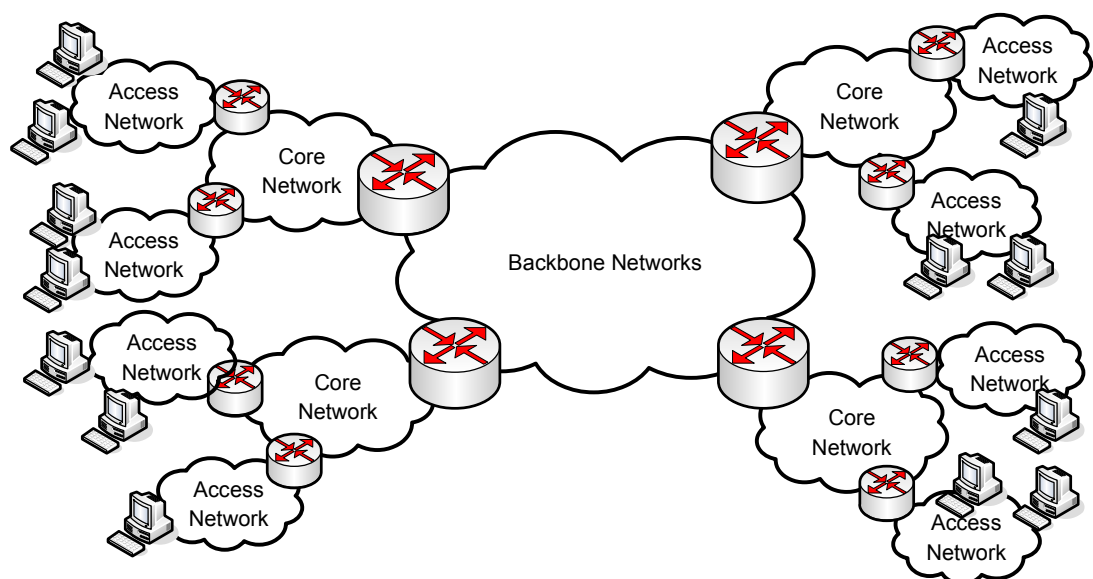

6

Coverage Area

- ▶ *centimetres*; people, objects
 - ▶ Body Area Network
 - ▶ Personal Area Network
 - ▶ Infrared, Bluetooth, ZigBee, IEEE 802.15.4, ...
- ▶ *metres*; homes, offices, buildings
 - ▶ Local Area Network
 - ▶ Home Area Network
 - ▶ Storage Area Network
 - ▶ IEEE 802.3 (Ethernet), IEEE 802.11 (WiFi), Fibre Channel ...
- ▶ *kilometres*; cities, countries, between countries
 - ▶ Metropolitan Area Network
 - ▶ Wide Area Network
 - ▶ PDH, SDH, ATM, Frame-Relay, WiMax, satellite, ...
- ▶ *megametres*; globe, between planets
 - ▶ Global Area Network
 - ▶ the Internet, interplanetary networks

7

WANs and LANs

Wide Area Networks

- ▶ Connect devices/networks over large geographical area
- ▶ Between campuses, office buildings, cities, countries
- ▶ Owned and operated by organisations on behalf of users, e.g. TOT, CAT, TT&T
- ▶ Leased to users, e.g. unis, companies, smaller ISPs

Local Area Networks

- ▶ Connect end-user devices over small area
- ▶ Within campuses, buildings, homes
- ▶ Owned and operated by organisation using the network
- ▶ Typically support higher data rates than WANs (internal communications, multiplexing)

8

Contents

General Network Issues

Network Topologies

Medium Access Control

Example Network Technologies

9

Network Topologies

- ▶ Topology: arrangement of nodes (devices) and links
 - ▶ Devices with data to communicate to others: stations, hosts, end nodes
 - ▶ Devices that support communications: switches, repeaters, hubs
 - ▶ Links: point-to-point, point-to-multipoint
- Mesh** every station has point-to-point link to every other station
- Bus** every station connected via a multipoint link
- Ring** point-to-point links between pairs of stations, or via special link, to form ring
- Star** every station has point-to-point link to central device
- Hybrid** combination of 2 or more of above, e.g. tree is combination of star and bus topologies

Topology Design Requirements

- ▶ Station should be able to communicate with any other station
- ▶ Dedicated point-to-point links are better than shared multipoint links
- ▶ Use as few links as possible
- ▶ Scales well: adding a new node requires little effort
- ▶ Fault-tolerant: failure of a link still allows other nodes to communicate; failure of a device doesn't prevent other nodes from communicating
- ▶ Fault-detection: a fault can be automatically detected by network

11

Mesh Topology

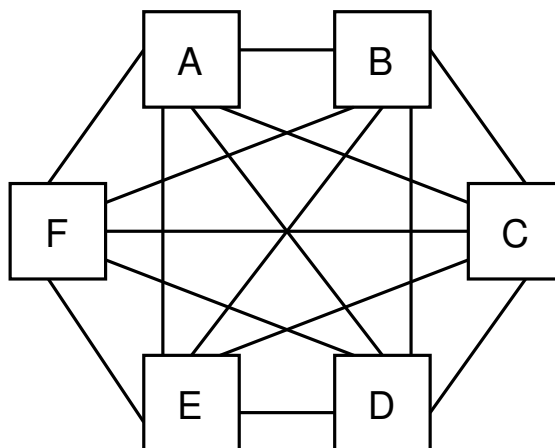

- ▶ Used in small WANs; becomes too complex as number of nodes increase
- ▶ Each pair of nodes have dedicated point-to-point link
- ▶ Addresses not needed in frames

12

Partial Mesh Topology

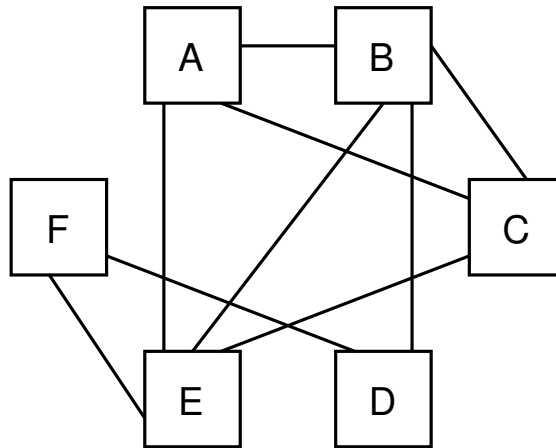

- ▶ Selection of node pairs have point-to-point link
- ▶ Some pairs cannot communicate, unless nodes can forward data (see Internet topic)
- ▶ Used in WANs

13

Bus Topology

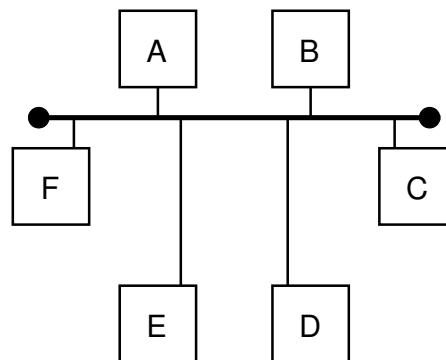

- ▶ Used in early (Ethernet) LANs, but replaced by star
- ▶ Single multipoint link connects all stations
- ▶ Transmission propagates throughout medium and is heard by all stations
- ▶ Terminator absorbs frames at end of medium/cable
- ▶ Frames need addresses
- ▶ Pros: easy installation
- ▶ Cons: require protocols to share medium; faulty link stops all communications; limited number of stations

14

Ring Topology

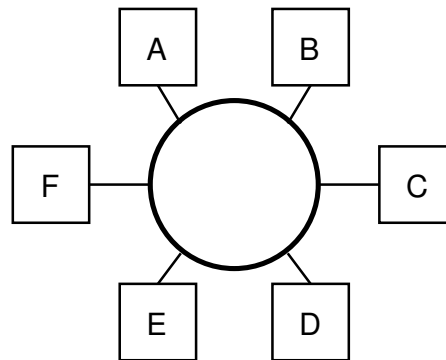

- ▶ Unidirectional point-to-point links to form loop
- ▶ Stations attach to repeaters
- ▶ Frames need addresses
- ▶ Pros: simple to install and reconfigure; easy to identify faults
- ▶ Cons: require protocols to share medium; traffic flows in one direction
- ▶ Usage: old LANs (e.g. IBM/IEEE 802.5 Token Ring); MANs and WANs

15

Star Topology

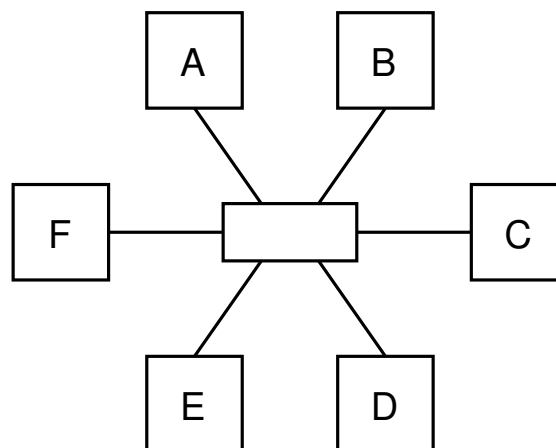

- ▶ Traffic between stations goes via the central node
- ▶ Usually two point-to-point links between station and central node (or duplex link)
- ▶ Frames needed addresses
- ▶ Pros: easy to install; fault tolerance for links
- ▶ Cons: depends on central node
- ▶ Usage: Most LANs today

16

Contents

General Network Issues

Network Topologies

Medium Access Control

Example Network Technologies

17

Multiple Users Using in Point-to-Multipoint Links

- ▶ Multiple users share a point-to-multipoint link
- ▶ Typical for wireless systems (WiFi, mobile phone) and some wired LANs
- ▶ Use *multiple access* schemes to determine who transmits and when

Fixed Assignment FDMA, TDMA, CDMA, SDMA

- requires planning and coordination, inefficient with dynamic traffic

Demand Assignment reservation, polling

- complex, high overheads or central coordinator

Random Access Aloha, CSMA

- unpredictable performance

Demand assignment and random access called Medium Access Control (MAC)

18

Medium Access Control

- ▶ In a shared medium, if two (or more) stations transmit at the same time, there is a chance the two transmissions will interfere with each other
- ▶ Collision of frames: receiver receives two or more frames partially overlapping in time; assume all frames are corrupted/lost
- ▶ Medium Access Control: allow one station to use the shared medium at a time (avoiding collisions)
- ▶ MAC techniques must give stations opportunities to transmit: fair and efficient

Demand Assignment reservation, polling, round-robin

- ▶ Stations are coordinated by a schedule

Random Access Aloha, CSMA

- ▶ Stations wait a random time and transmit if no-one else is currently transmitting

19

MAC Examples

20

General Network Issues

Network Topologies

Medium Access Control

Example Network Technologies

21

Asynchronous Transfer Mode

- ▶ Virtual circuit packet switching network technology
- ▶ Fixed sized packets, asynchronous (statistical) TDM, connection-oriented
- ▶ Can offer performance guarantees, Quality of Service (QoS) control
- ▶ Data rates up to 622 Mb/s
- ▶ Popular with telephone companies (e.g. connect telephone exchanges, mobile phone base stations); but being replaced by all IP networks
- ▶ Used in some DSL links: PPP over ATM, alternative is PPP over Ethernet
- ▶ Related technologies: X.25, Frame-Relay, MPLS, IP

22

ATM Network Example

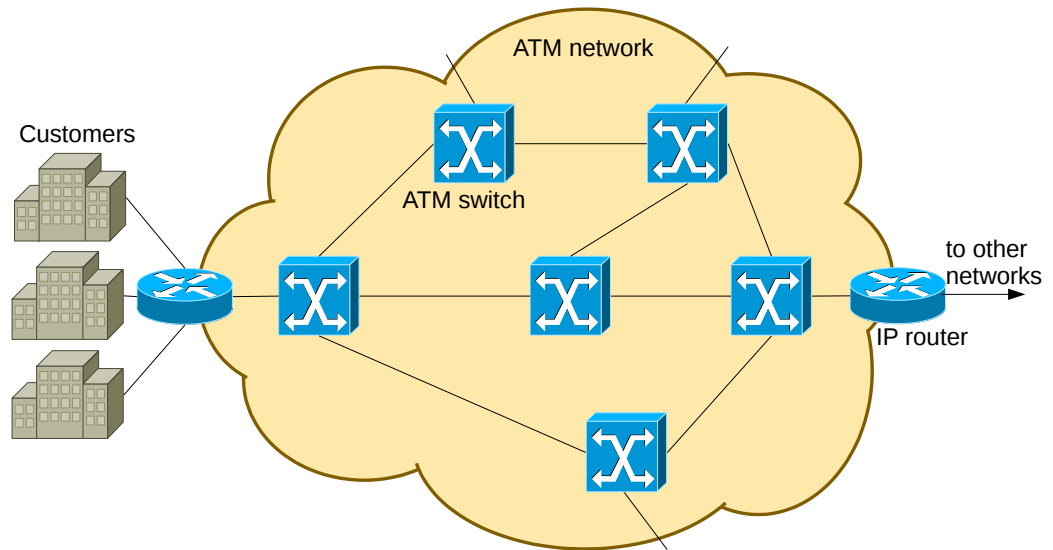

Multiplexing in Telephone Networks

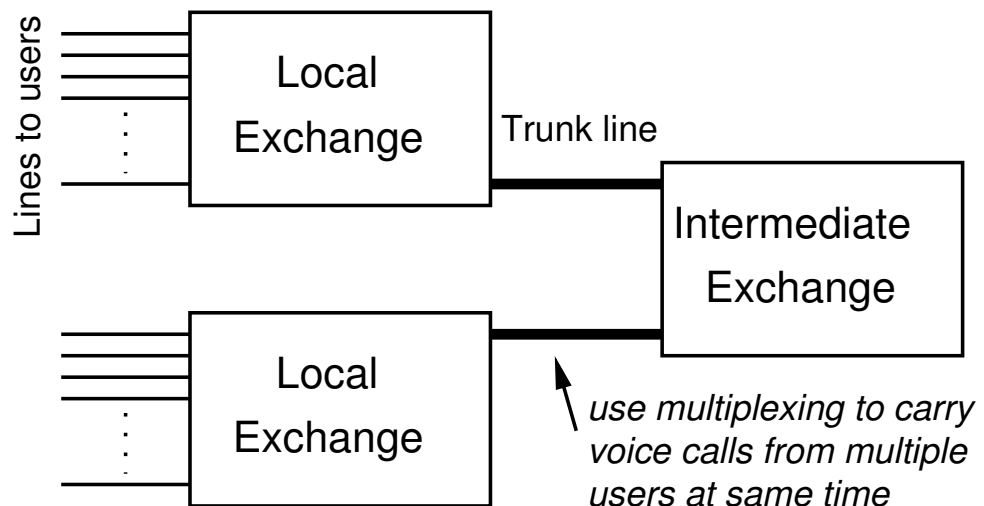

- ▶ Analog signal from home user to local exchange
- ▶ Exchange converts to digital to transmit to next exchange
 - ▶ Voice: bandwidth 4 kHz, sampling rate 8 kHz, 8-bit PCM → 64 kb/s

T-Carrier, E-Carrier and PDH

- ▶ Telecom companies used digital transmission with electrical signals and TDM to carry multiple voice calls
- ▶ 1 voice call = 64 kb/s
- ▶ Originally Transmission System 1 (T1) carried 24 voice calls in US
- ▶ Increased data rates (in Europe, E-Carrier)
 - ▶ T1: 1.5 Mb/s; T2: 6Mb/s; T3: 44 Mb/s; T4: 274Mb/s
 - ▶ E1: 2 Mb/s; E2: 8Mb/s; E3: 34 Mb/s; E4: 140 Mb/s
- ▶ Transmitter and receiver must know when time slots start/end → require accurate synchronisation
- ▶ General name: Plesionchronous Digital Hierarchy
- ▶ Although original designed based on carrying voice, can carry any digital data
- ▶ Leased lines: telecom companies lease a line (e.g. E1, E2, E3) to other organisations

25

PDH and SDH Data Rates

PDH (E-Carrier)

Level	Channels	Data Rate
E1	32	2 Mb/s
E2	128	8 Mb/s
E3	512	34 Mb/s
E4	2048	140 Mb/s
E5	8192	565 Mb/s

SDH

Optical	Level	Data Rate
OC-3	STM-1	155 Mb/s
OC-12	STM-4	622 Mb/s
OC-48	STM-16	2.5 Gb/s
OC-192	STM-64	10 Gb/s
OC-768	STM-256	40 Gb/s

26

Synchronous Digital Hierarchy

- ▶ Developed to increase performance of PDH, support optical carrier (OC) signals
- ▶ SONET in US, SDH in rest of world
- ▶ Transmit frame every $125 \mu\text{s}$; requires more accurate synchronisation than PDH (atomic clocks)
- ▶ Built-in fault tolerance: transmit on at least two fibres; can support ring topology with redundant transmissions in each direction
- ▶ Used in many networks across cities/countries, and links between countries
- ▶ Optical fibres:
 - ▶ Single optical fibre can carry multiple optical signals using Wavelength Division Multiplexing
 - ▶ Each optical signal may carry SDH or 10 Gb/s Ethernet

27

LAN Technologies

- ▶ IEEE 802.3 (Ethernet)
- ▶ IEEE 802.11 wireless LANs (WiFi)
- ▶ Older technologies, e.g. Token Ring, FDDI
- ▶ Infiniband: connect servers, storage devices, high-performance computers
- ▶ Power-line communications (PLC): HomePlug, IEEE 1901, ITU-T G.hn

28

And Many Others

LANs & WANs

Issues

Topologies

MAC

Examples

- ▶ Narrowband: dialup modems, ISDN
- ▶ Broadband: HDSL, SDSL, ADSL, VDSL, DOCSIS, PON
- ▶ Mobile Telephony: GSM, GPRS, EDGE, 3G (UMTS), HSPA, LTE; WiMax
- ▶ Wireless PANs: IrDA, IEEE 802.15.4, Bluetooth, Wireless USB
- ▶ ...