

# Block Ciphers and DES

## CSS322: Security and Cryptography

Sirindhorn International Institute of Technology  
Thammasat University

Prepared by Steven Gordon on 7 November 2010  
CSS322Y10S2L03, Steve/Courses/CSS322/Lectures/des.tex, r1489

# Contents

Principles

DES

S-DES

DES Details

DES Design

Other Ciphers

## Block Cipher Principles

## The Data Encryption Standard

## Simplified-DES

## DES Details

## DES Design Issues and Attacks

## 3DES, AES and Other Block Ciphers

# Stream Ciphers

- ▶ Encrypts a digital data stream one bit or one byte at a time
- ▶ One time pad is example; but practical limitations
- ▶ Typical approach for stream cipher:
  - ▶ Key ( $K$ ) used as input to bit-stream generator algorithm
  - ▶ Algorithm generates cryptographic bit stream ( $k_i$ ) used to encrypt plaintext
  - ▶ Users share a key; use it to generate keystream

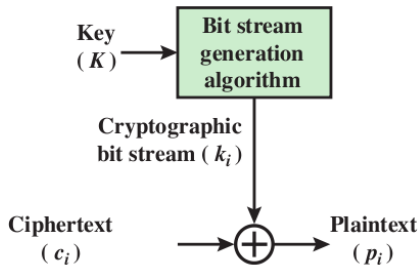
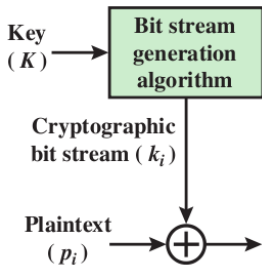

# Block Ciphers

- ▶ Encrypt a block of plaintext as a whole to produce same sized ciphertext
- ▶ Typical block sizes are 64 or 128 bits
- ▶ Modes of operation used to apply block ciphers to larger plaintexts

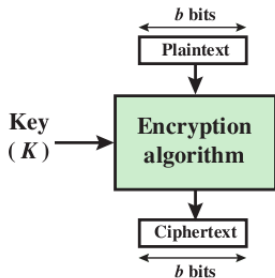

# Reversible and Irreversible Mappings

- ▶  $n$ -bit block cipher takes  $n$  bit plaintext and produces  $n$  bit ciphertext
- ▶  $2^n$  possible different plaintext blocks
- ▶ Encryption must be reversible (decryption possible)
- ▶ Each plaintext block must produce unique ciphertext block
- ▶ Total transformations is  $2^n!$

Reversible Mapping		Irreversible Mapping	
Plaintext	Ciphertext	Plaintext	Ciphertext
00	11	00	11
01	10	01	10
10	00	10	01
11	01	11	01

# Ideal Block Cipher

- ▶  $n$ -bit input maps to  $2^n$  possible input states
- ▶ Substitution used to produce  $2^n$  output states
- ▶ Output states map to  $n$ -bit output
- ▶ Ideal block cipher allows maximum number of possible encryption mappings from plaintext block
- ▶ Problems with ideal block cipher:
  - ▶ Small block size: equivalent to classical substitution cipher; cryptanalysis based on statistical characteristics feasible
  - ▶ Large block size: key must be very large; performance/implementation problems

# General Block Substitution

Principles

DES

S-DES

DES Details

DES Design

Other Ciphers

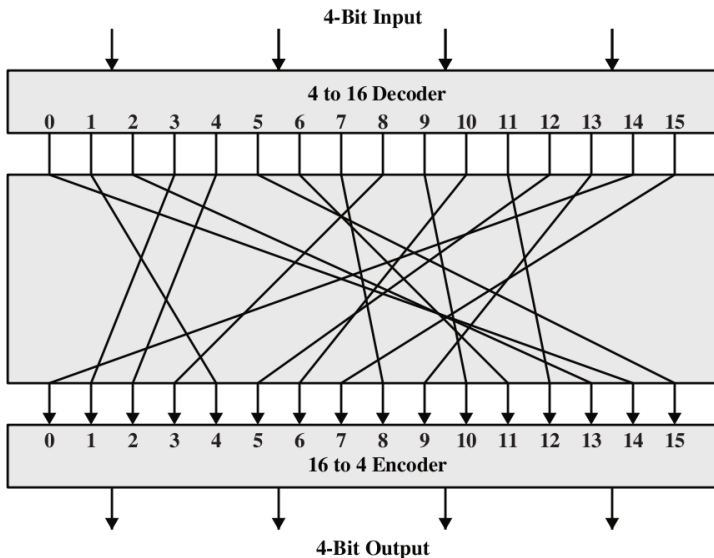

## Encryption/Decryption Tables

## Block Ciphers

## Principles

## DES

## S-DES

## DES Details

## DES Design

## Other Ciphers

Plaintext	Ciphertext
0000	1110
0001	0100
0010	1101
0011	0001
0100	0010
0101	1111
0110	1011
0111	1000
1000	0011
1001	1010
1010	0110
1011	1100
1100	0101
1101	1001
1110	0000
1111	0111

Ciphertext	Plaintext
0000	1110
0001	0011
0010	0100
0011	1000
0100	0001
0101	1100
0110	1010
0111	1111
1000	0111
1001	1101
1010	1001
1011	0110
1100	1011
1101	0010
1110	0000
1111	0101



# Feistel Structure for Block Ciphers

- ▶ Feistel proposed applying two or more simple ciphers in sequence so final result is cryptographically stronger than component ciphers
- ▶  $n$ -bit block length;  $k$ -bit key length;  $2^k$  transformations
- ▶ Feistel cipher alternates: substitutions, transpositions (permutations)
- ▶ Applies concepts of **diffusion** and **confusion**
- ▶ Applied in many ciphers today
- ▶ Approach:
  - ▶ Plaintext split into halves
  - ▶ Subkeys (or round keys) generated from key
  - ▶ Round function,  $F$ , applied to right half
  - ▶ Apply substitution on left half using XOR
  - ▶ Apply permutation: interchange to halves

# Diffusion and Confusion

## Diffusion

- ▶ Statistical nature of plaintext is reduced in ciphertext
- ▶ E.g. A plaintext letter affects the value of many ciphertext letters
- ▶ How: repeatedly apply permutation (transposition) to data, and then apply function

## Confusion

- ▶ Make relationship between ciphertext and key as complex as possible
- ▶ Even if attacker can find some statistical characteristics of ciphertext, still hard to find key
- ▶ How: apply complex (non-linear) substitution algorithm

# Feistel Encryption and Decryption

Principles

DES

S-DES

DES Details

DES Design

Other Ciphers

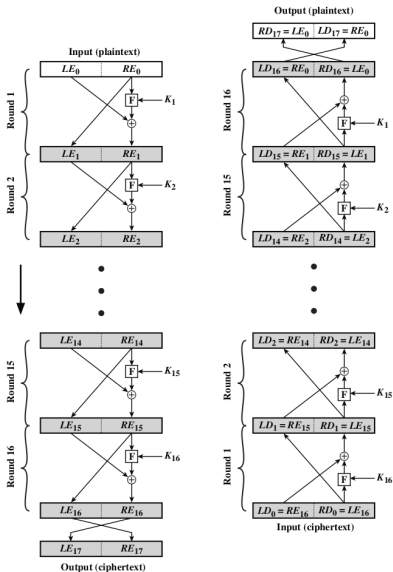

# Using the Feistel Structure

- ▶ Exact implementation depends on various design features
  - ▶ Block size, e.g. 64, 128 bits: larger values leads to more diffusion
  - ▶ Key size, e.g. 128 bits: larger values leads to more confusion, resistance against brute force
  - ▶ Number of rounds, e.g. 16 rounds
  - ▶ Subkey generation algorithm: should be complex
  - ▶ Round function  $F$ : should be complex
- ▶ Other factors include fast encryption in software and ease of analysis
- ▶ Tradeoff: security vs performance

## Feistel Example

Principles

DES

S-DES

DES Details

DES Design

Other Ciphers

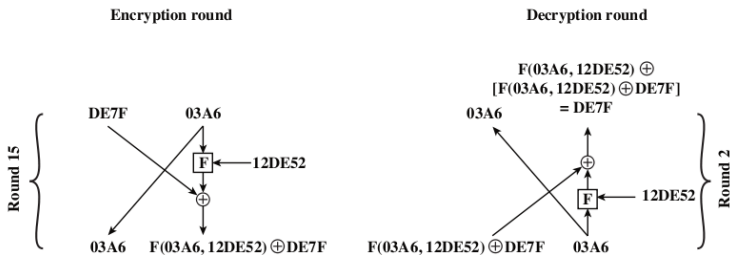

# Contents

Principles

DES

S-DES

DES Details

DES Design

Other Ciphers

Block Cipher Principles

The Data Encryption Standard

Simplified-DES

DES Details

DES Design Issues and Attacks

3DES, AES and Other Block Ciphers

# Data Encryption Standard

- ▶ Symmetric block cipher
  - ▶ 56-bit key, 64-bit input block, 64-bit output block
- ▶ One of most used encryption systems in world
  - ▶ Developed in 1977 by NBS/NIST
  - ▶ Designed by IBM (Lucifer) with input from NSA
  - ▶ Principles used in other ciphers, e.g. 3DES, IDEA
- ▶ Simplified DES (S-DES)
  - ▶ Cipher using principles of DES
  - ▶ Developed for education (not real world use)

# Contents

Principles

DES

**S-DES**

DES Details

DES Design

Other Ciphers

Block Cipher Principles

The Data Encryption Standard

**Simplified-DES**

DES Details

DES Design Issues and Attacks

3DES, AES and Other Block Ciphers



# Simplified DES

- ▶ Input (plaintext) block: 8-bits
- ▶ Output (ciphertext) block: 8-bits
- ▶ Key: 10-bits
- ▶ Rounds: 2
- ▶ Round keys generated using permutations and left shifts
- ▶ Encryption: initial permutation, round function, switch halves
- ▶ Decryption: Same as encryption, except round keys used in opposite order

## S-DES Algorithm

Principles

DES

S-DES

DES Details

DES Design

Other Ciphers

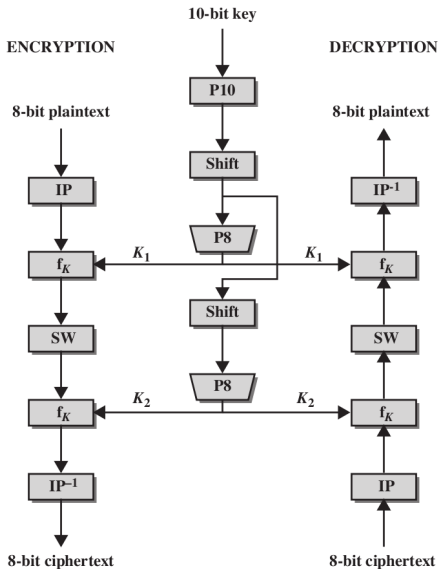

# S-DES Operations

- ▶ P10 (permutate)

Input : 1 2 3 4 5 6 7 8 9 10

Output: 3 5 2 7 4 10 1 9 8 6

- ▶ P8 (select and permutate)

Input : 1 2 3 4 5 6 7 8 9 10

Output: 6 3 7 4 8 5 10 9

- ▶ P4 (permutate)

Input : 1 2 3 4

Output: 2 4 3 1

# S-DES Operations

- ▶ EP (expand and permute)

Input : 1 2 3 4

Output: 4 1 2 3 2 3 4 1

- ▶ IP (initial permutation)

Input : 1 2 3 4 5 6 7 8

Output: 2 6 3 1 4 8 5 7

- ▶  $IP^{-1}$  (inverse of IP)
- ▶ LS-1 (left shift 1 position)
- ▶ LS-2 (left shift 2 positions)

## S-DES Key Generation

## Block Ciphers

Principles

DES

S-DES

DES Details

DES Design

Other Ciphers

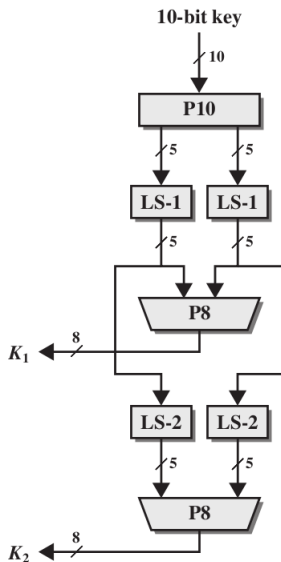

## S-DES Encryption Details

## Block Ciphers

Principles

DES

S-DES

DES Details

DES Design

Other Ciphers

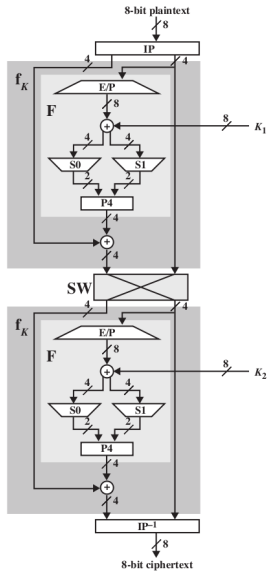

## S-DES S-Boxes

- ▶ S-DES (and DES) perform substitutions using S-Boxes
- ▶ S-Box considered as a matrix: input used to select row/column; selected element is output
- ▶ 4-bit input:  $bit_1, bit_2, bit_3, bit_4$
- ▶  $bit_1 bit_4$  specifies row (0, 1, 2 or 3 in decimal)
- ▶  $bit_2 bit_3$  specifies column
- ▶ 2-bit output

$$S_0 = \begin{bmatrix} 01 & 00 & 11 & 10 \\ 11 & 10 & 01 & 00 \\ 00 & 10 & 01 & 11 \\ 11 & 01 & 11 & 10 \end{bmatrix} \quad S_1 = \begin{bmatrix} 00 & 01 & 10 & 11 \\ 10 & 00 & 01 & 11 \\ 11 & 00 & 01 & 00 \\ 10 & 01 & 00 & 11 \end{bmatrix}$$

# S-DES Example

- ▶ Plaintext: 01110010
- ▶ Key: 1010000010
- ▶ Ciphertext: 01110111



# S-DES Summary

- ▶ Educational encryption algorithm
- ▶ S-DES expressed as functions:

$$ciphertext = IP^{-1} (f_{K_2} (SW (f_{K_1} (IP (plaintext))))))$$

$$plaintext = IP^{-1} (f_{K_1} (SW (f_{K_2} (IP (ciphertext))))))$$

- ▶ Security of S-DES:
  - ▶ 10-bit key, 1024 keys: brute force easy
  - ▶ If know plaintext and corresponding ciphertext, can we determine key? **Very hard**

# Comparing DES and S-DES

Principles

DES

S-DES

DES Details

DES Design

Other Ciphers

## S-DES

- ▶ 8-bit blocks
- ▶ 10-bit key: 2 × 8-bit round keys
- ▶ IP: 8-bits
- ▶  $F$  operates on 4 bits
- ▶ 2 S-Boxes
- ▶ 2 rounds

S-DES encryption:

$$ciphertext = IP^{-1} (f_{K_2} (SW (f_{K_1} (IP (plaintext))))))$$

DES encryption:

$$ciphertext = IP^{-1} (f_{K_{16}} (SW (f_{K_{15}} (SW (\dots (f_{K_1} (IP (plaintext))))))))$$

## DES

- ▶ 64-bit blocks
- ▶ 56-bit key: 16 × 48-bit round keys
- ▶ IP: 64 bits
- ▶  $F$  operates on 32 bits
- ▶ 8 S-Boxes
- ▶ 16 rounds

# Contents

Principles

DES

S-DES

**DES Details**

DES Design

Other Ciphers

Block Cipher Principles

The Data Encryption Standard

Simplified-DES

**DES Details**

DES Design Issues and Attacks

3DES, AES and Other Block Ciphers

# General DES Encryption Algorithm

Principles

DES

S-DES

DES Details

DES Design

Other Ciphers

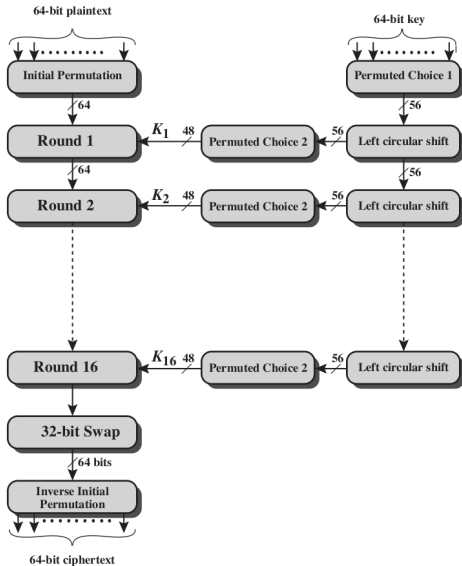

# Permutation Tables for DES

Principles

DES

S-DES

DES Details

DES Design

Other Ciphers

(a) Initial Permutation (IP)

58	50	42	34	26	18	10	2
60	52	44	36	28	20	12	4
62	54	46	38	30	22	14	6
64	56	48	40	32	24	16	8
57	49	41	33	25	17	9	1
59	51	43	35	27	19	11	3
61	53	45	37	29	21	13	5
63	55	47	39	31	23	15	7

(b) Inverse Initial Permutation ( $IP^{-1}$ )

40	8	48	16	56	24	64	32
39	7	47	15	55	23	63	31
38	6	46	14	54	22	62	30
37	5	45	13	53	21	61	29
36	4	44	12	52	20	60	28
35	3	43	11	51	19	59	27
34	2	42	10	50	18	58	26
33	1	41	9	49	17	57	25

# Permutation Tables for DES

Principles

DES

S-DES

DES Details

DES Design

Other Ciphers

(c) Expansion Permutation (E)

32	1	2	3	4	5
4	5	6	7	8	9
8	9	10	11	12	13
12	13	14	15	16	17
16	17	18	19	20	21
20	21	22	23	24	25
24	25	26	27	28	29
28	29	30	31	32	1

(d) Permutation Function (P)

16	7	20	21	29	12	28	17
1	15	23	26	5	18	31	10
2	8	24	14	32	27	3	9
19	13	30	6	22	11	4	25

# Single Round of DES Algorithm

Principles

DES

S-DES

DES Details

DES Design

Other Ciphers

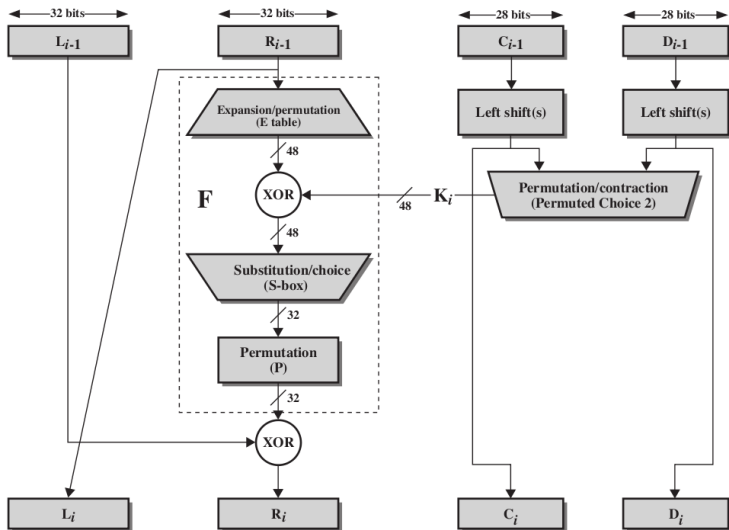

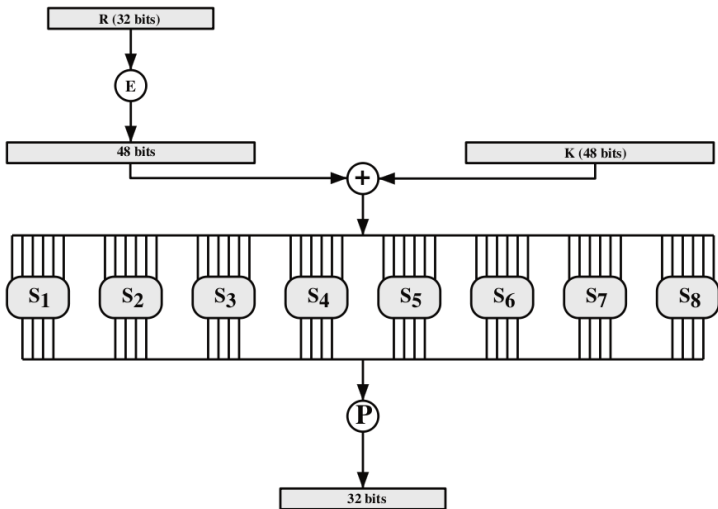
Calculation of  $F(R,K)$ 



## Definition of DES S-Boxes

Principles

DES

S-DES

DES Details

DES Design

Other Ciphers

 $S_1$ 

14	4	13	1	2	15	11	8	3	10	6	12	5	9	0	7
0	15	7	4	14	2	13	1	10	6	12	11	9	5	3	8
4	1	14	8	13	6	2	11	15	12	9	7	3	10	5	0
15	12	8	2	4	9	1	7	5	11	3	14	10	0	6	13

 $S_2$ 

15	1	8	14	6	11	3	4	9	7	2	13	12	0	5	10
3	13	4	7	15	2	8	14	12	0	1	10	6	9	11	5
0	14	7	11	10	4	13	1	5	8	12	6	9	3	2	15
13	8	10	1	3	15	4	2	11	6	7	12	0	5	14	9

 $S_3$ 

10	0	9	14	6	3	15	5	1	13	12	7	11	4	2	8
13	7	0	9	3	4	6	10	2	8	5	14	12	11	15	1
13	6	4	9	8	15	3	0	11	1	2	12	5	10	14	7
1	10	13	0	6	9	8	7	4	15	14	3	11	5	2	12

 $S_4$ 

7	13	14	3	0	6	9	10	1	2	8	5	11	12	4	15
13	8	11	5	6	15	0	3	4	7	2	12	1	10	14	9
10	6	9	0	12	11	7	13	15	1	3	14	5	2	8	4
3	15	0	6	10	1	13	8	9	4	5	11	12	7	2	14

## Definition of DES S-Boxes

## Block Ciphers

## Principles

## DES

## S-DES

## DES Details

## DES Design

## Other Ciphers

$S_5$

2	12	4	1	7	10	11	6	8	5	3	15	13	0	14	9
14	11	2	12	4	7	13	1	5	0	15	10	3	9	8	6
4	2	1	11	10	13	7	8	15	9	12	5	6	3	0	14
11	8	12	7	1	14	2	13	6	15	0	9	10	4	5	3

$S_6$

12	1	10	15	9	2	6	8	0	13	3	4	14	7	5	11
10	15	4	2	7	12	9	5	6	1	13	14	0	11	3	8
9	14	15	5	2	8	12	3	7	0	4	10	1	13	11	6
4	3	2	12	9	5	15	10	11	14	1	7	6	0	8	13

$S_7$

4	11	2	14	15	0	8	13	3	12	9	7	5	10	6	1
13	0	11	7	4	9	1	10	14	3	5	12	2	15	8	6
1	4	11	13	12	3	7	14	10	15	6	8	0	5	9	2
6	11	13	8	1	4	10	7	9	5	0	15	14	2	3	12

$S_8$

13	2	8	4	6	15	11	1	10	9	3	14	5	0	12	7
1	15	13	8	10	3	7	4	12	5	6	11	0	14	9	2
7	11	4	1	9	12	14	2	0	6	10	13	15	3	5	8
2	1	14	7	4	10	8	13	15	12	9	0	3	5	6	11

# DES Key Schedule Calculation

Principles

DES

S-DES

DES Details

DES Design

Other Ciphers

(a) Input Key

1	2	3	4	5	6	7	8
9	10	11	12	13	14	15	16
17	18	19	20	21	22	23	24
25	26	27	28	29	30	31	32
33	34	35	36	37	38	39	40
41	42	43	44	45	46	47	48
49	50	51	52	53	54	55	56
57	58	59	60	61	62	63	64

(b) Permuted Choice One (PC-1)

57	49	41	33	25	17	9
1	58	50	42	34	26	18
10	2	59	51	43	35	27
19	11	3	60	52	44	36
63	55	47	39	31	23	15
7	62	54	46	38	30	22
14	6	61	53	45	37	29
21	13	5	28	20	12	4

(c) Permuted Choice Two (PC-2)

14	17	11	24	1	5	3	28
15	6	21	10	23	19	12	4
26	8	16	7	27	20	13	2
41	52	31	37	47	55	30	40
51	45	33	48	44	49	39	56
34	53	46	42	50	36	29	32

(d) Schedule of Left Shifts

Round Number	1	2	3	4	5	6	7	8	9	10	11	12	13	14	15	16
Bits Rotated	1	1	2	2	2	2	2	2	1	2	2	2	2	2	2	1

# Contents

Principles

DES

S-DES

DES Details

**DES Design**

Other Ciphers

Block Cipher Principles

The Data Encryption Standard

Simplified-DES

DES Details

**DES Design Issues and Attacks**

3DES, AES and Other Block Ciphers

# The Avalanche Effect

Aim: small change in key (or plaintext) produces large change in ciphertext

- ▶ Avalanche effect is present in DES (good for security)
- ▶ Following examples show the number of bits that change in output when two different inputs are used, differing by 1 bit
  - ▶ Plaintext 1: 02468aceeca86420  
Plaintext 2: 12468aceeca86420  
Ciphertext difference: 32 bits
  - ▶ Key 1: 0f1571c947d9e859  
Key 2: 1f1571c947d9e859  
Ciphertext difference: 30

## Avalanche Effect in DES: Change in Plaintext

Principles

DES

S-DES

DES Details

DES Design

Other Ciphers

Round		$\delta$
	02468aceeca86420 12468aceeca86420	1
1	3cf03c0fbad22845 3cf03c0fbad32845	1
2	bad2284599e9b723 bad3284539a9b7a3	5
3	99e9b7230bae3b9e 39a9b7a3171cb8b3	18
4	0bae3b9e42415649 171cb8b3ccaca55e	34
5	4241564918b3fa41 ccaca55ed16c3653	37
6	18b3fa419616fe23 d16c3653cf402c68	33
7	9616fe2367117cf2 cf402c682b2cefbc	32
8	67117cf2c11bfc09 2b2cefbc99f91153	33

Round		$\delta$
9	c11bfc09887fbc6c 99f911532eed7d94	32
10	887fbc6c600f7e8b 2eed7d94d0f23094	34
11	600f7e8bf596506e d0f23094455da9c4	37
12	f596506e738538b8 455da9c47f6e3cf3	31
13	738538b8c6a62c4e 7f6e3cf34bc1a8d9	29
14	c6a62c4e56b0bd75 4bc1a8d91e07d409	33
15	56b0bd7575e8fd8f 1e07d4091ce2e6dc	31
16	75e8fd8f25896490 1ce2e6dc365e5f59	32
IP <sup>-1</sup>	da02ce3a89ecac3b 057cde97d7683f2a	32

## Avalanche Effect in DES: Change in Key

Principles

DES

S-DES

DES Details

DES Design

Other Ciphers

Round		$\delta$
	02468aceeca86420 02468aceeca86420	0
1	3cf03c0fbad22845 3cf03c0f9ad628c5	3
2	bad2284599e9b723 9ad628c59939136b	11
3	99e9b7230bae3b9e 9939136b768067b7	25
4	0bae3b9e42415649 768067b75a8807c5	29
5	4241564918b3fa41 5a8807c5488dbe94	26
6	18b3fa419616fe23 488dbe94aba7fe53	26
7	9616fe2367117cf2 aba7fe53177d21e4	27
8	67117cf2c11bfc09 177d21e4548f1de4	32

Round		$\delta$
9	c11bfc09887fbc6c 548f1de471f64dfd	34
10	887fbc6c600f7e8b 71f64dfd4279876c	36
11	600f7e8bf596506e 4279876c399fdc0d	32
12	f596506e738538b8 399fdc0d6d208dbb	28
13	738538b8c6a62c4e 6d208dbbb9bdeea	33
14	c6a62c4e56b0bd75 b9bdeeaad2c3a56f	30
15	56b0bd7575e8fd8f d2c3a56f2765c1fb	33
16	75e8fd8f25896490 2765c1fb01263dc4	30
IP <sup>-1</sup>	da02ce3a89ecac3b ee92b50606b62b0b	30

# Key Size

- ▶ Although 64 bit initial key, only 56 bits used in encryption (other 8 for parity check)
- ▶  $2^{56} = 7.2 \times 10^{16}$ 
  - ▶ 1977: estimated cost \$US20m to build machine to break in 10 hours
  - ▶ 1998: EFF built machine for \$US250k to break in 3 days
  - ▶ Today: 56 bits considered too short to withstand brute force attack
- ▶ 3DES uses 128-bit keys



# Attacks on DES

## Timing Attacks

- ▶ Information gained about key/plaintext by observing how long implementation takes to decrypt
- ▶ No known useful attacks on DES

## Differential Cryptanalysis

- ▶ Observe how pairs of plaintext blocks evolve
- ▶ Break DES in  $2^{47}$  encryptions (compared to  $2^{55}$ ); but require  $2^{47}$  chosen plaintexts

## Linear Cryptanalysis

- ▶ Find linear approximations of the transformations
- ▶ Break DES using  $2^{43}$  known plaintexts

# DES Algorithm Design

DES was designed in private; questions about the motivation of the design

- ▶ S-Boxes provide non-linearity: important part of DES, generally considered to be secure
- ▶ S-Boxes provide increased confusion
- ▶ Permutation P chosen to increase diffusion

# Contents

Principles

DES

S-DES

DES Details

DES Design

Other Ciphers

Block Cipher Principles

The Data Encryption Standard

Simplified-DES

DES Details

DES Design Issues and Attacks

3DES, AES and Other Block Ciphers

# Multiple Encryption with DES

- ▶ DES is vulnerable to brute force attack
- ▶ Alternative block cipher that makes use of DES software/equipment/knowledge: encrypt multiple times with different keys
- ▶ Options:
  1. Double DES: not much better than single DES
  2. Triple DES (3DES) with 2 keys: brute force  $2^{112}$
  3. Triple DES with 3 keys: brute force  $2^{168}$

# Double Encryption

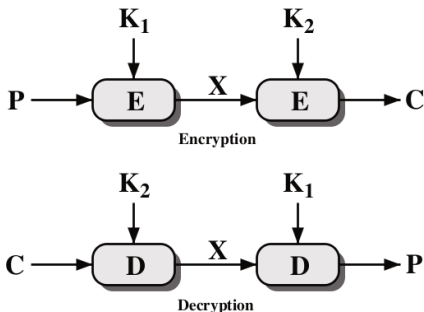

- ▶ For DES,  $2 \times 56$ -bit keys, meaning 112-bit key length
- ▶ Requires  $2^{111}$  operations for brute force?
- ▶ **Meet-in-the-middle** attack makes it easier

# Meet-in-the-Middle Attack

- ▶ Double DES Encryption:  $C = E(K_2, E(K_1, P))$
- ▶ Say  $X = E(K_1, P) = D(K_2, C)$
- ▶ Attacker knows two plaintext, ciphertext pairs  $(P_a, C_a)$  and  $(P_b, C_b)$ 
  1. Encrypt  $P_a$  using all  $2^{56}$  values of  $K_1$  to get multiple values of  $X$
  2. Store results in table and sort by  $X$
  3. Decrypt  $C_a$  using all  $2^{56}$  values of  $K_2$
  4. As each decryption result produced, check against table
  5. If match, check current  $K_1, K_2$  on  $C_b$ . If  $P_b$  obtained, then accept the keys
- ▶ With two known plaintext, ciphertext pairs, probability of successful attack is almost 1
- ▶ Encrypt/decrypt operations required:  $2^{56}$  (twice as many as single DES)

# Triple Encryption

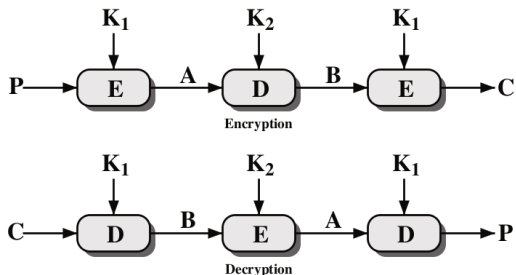

- ▶ 2 keys, 112 bits
- ▶ 3 keys, 168 bits
- ▶ Why E-D-E? To be compatible with single DES:

$$C = E(K_1, D(K_1, E(K_1, P))) = E(K_1, P)$$

# Advanced Encryption Standard

- ▶ NIST called for proposals for new standard in 1997
  - ▶ Aims: security, efficient software/hardware implementations, low memory requirements, parallel processing
  - ▶ Candidate algorithms from around the world
  - ▶ Rijndael chosen, standard called AES created in 2001
- ▶ AES:
  - ▶ Block size: 128 bits (others possible)
  - ▶ Key size: 128, 192, 256 bits
  - ▶ Rounds: 10, 12, 14 (depending on key)
  - ▶ Operations: XOR with round key, substitutions using S-Boxes, mixing using Galois Field arithmetic
- ▶ Widely used in file encryption, network communications
- ▶ Generally considered secure
- ▶ See textbook for details (including S-AES)



# Other Block Ciphers

- ▶ Blowfish (Schneier, open)
- ▶ Twofish (Schneier et al., open)
- ▶ IDEA (patented)
- ▶ Skipjack (NSA, Clipper)
- ▶ ...